



ON Semiconductor®

<http://onsemi.com>

# LA1837M

Monolithic Linear IC

## Single-Chip AM/FM Tuner IC for Home Stereo Systems

### Overview

The LA1837M is a single-chip AM/FM tuner IC that provides AM and FM IF and multiplex decoding circuits for electronic tuning and was developed for use in home stereo systems. It provides both SD and IF counting techniques for optimal implementation of automatic station selection.

### Features

- On-chip MPX VCO circuit (no external components required).
- Adjacent channel interference rejection function (third order and fifth order).
- Supports both the SD and IF counting technique (built-in SD speedup function).
- The AM and FM SD sensitivity can be set independently.
- The AM and FM output levels can be set independently.
- Improved basic FM reception performance.

### Functions

- AM: RF amplifier, mixer, oscillator, IF amplifier, detector, AGC, oscillator buffer, S-meter, narrow band SD, IF buffer
- FM IF: IF amplifier, quadrature detector, S-meter, SD, S curve detection, IF buffer output
- Multiplex stereo decoding: PLL stereo decoder, stereo indicator, forced monaural, VCO stop function, post amplifier, audio muting, adjacent channel interference rejection function

### Specifications

**Maximum Ratings** at  $T_a = 25^\circ\text{C}$

Parameter	Symbol	Conditions	Ratings	Unit
Maximum supply voltage	$V_{CC\ max}$		12	V
Allowable power dissipation	$P_d\ max$	$T_a \leq 70^\circ\text{C}^*$	550	mW
Operating temperature	$T_{opr}$		-20 to +70	$^\circ\text{C}$
Storage temperature	$T_{stg}$		-40 to +125	$^\circ\text{C}$

\*: Mounting board: 114.3×76.1×1.6mm glass epoxy board

Stresses exceeding Maximum Ratings may damage the device. Maximum Ratings are stress ratings only. Functional operation above the Recommended Operating Conditions is not implied. Extended exposure to stresses above the Recommended Operating Conditions may affect device reliability.

# LA1837M

## Operating Conditions at $T_a = 25^\circ\text{C}$

Parameter	Symbol	Conditions	Ratings	Unit
Recommended supply voltage	$V_{CC}$		9	V
Operating supply voltage range	$V_{CC\text{ op}}$		7.0 to 11.0	V

## Electrical Characteristics at $T_a = 25^\circ\text{C}$ $V_{CC} = 9.0\text{V}$ , in the specified circuit.

Parameter	Symbol	Conditions	Ratings			Unit
			min	typ	max	
[FM Mono Characteristics] $f_c = 10.7\text{MHz}$ , $f_m = 1\text{kHz}$ , with the coil adjusted so that $V_{AFC} - V_{REG} = 0\text{V}$ .						
Current drain	$I_{CCO-FM}$	No input	18	31	44	mA
Demodulator output	$V_{OFM}$	100dB $\mu$ , 100% mod, pin 16 output	730	1100	1460	mVrms
Channel balance	C.B-mono	100dB $\mu$ , 100% mod, pin 16 output / pin 17 output	-1.5	0	+1.5	dB
Total harmonic distortion (mono)	THD <sub>FM1</sub>	100dB $\mu$ , 100% mod, pin 16 output		0.3	1.3	%
	THD <sub>FM2</sub>	100dB $\mu$ , 200% mod, pin 16 output		1.0	5.0	%
Signal-to-noise ratio	S/N <sub>FM</sub>	100dB $\mu$ , 100% mod, pin 16 output	72	80		dB
AM rejection ratio	AMR	100dB $\mu$ , AM 30% mod, pin 16 output	45	65		dB
Input limiting voltage	-3dB <sub>L.S</sub>	Referenced to 100dB $\mu$ , 100% mod, the input for output is -3dB down.	26	32	38	dB $\mu$
LED on sensitivity	$SD_{ON-FM}$		51	60	69	dB $\mu$
LED on bandwidth	$SD_{BW}$	100dB $\mu$	85	120	170	kHz
IF counter buffer output	$V_{IFBUFF-FM}$	100dB $\mu$ , pin 13 output	80	120	160	mVrms
S-meter output	$V_{SM\text{ FM}1}$	0dB $\mu$ , pin 11 output	0	0.1	0.5	V
	$V_{SM\text{ FM}2}$	100dB $\mu$ , pin 11 output	3.6	4.3	5.0	V
Muting attenuation	Mute Alt	100dB $\mu$ , 100% mod, the pin 16 output	75	85		dB
[FM Stereo Characteristics] $f_c = 10.7\text{MHz}$ , 100dB $\mu$ , $f_m = 1\text{kHz}$ , L+R = 90%, pilot = 10%						
Separation: L	SepL	Lmod. pin 16 output / pin 17 output	30	45		dB
Separation: R	SepR	Rmod. pin 17 output / pin 16 output	30	45		dB
Stereo on level	ST <sub>ON</sub>	The pilot mod such that $V_7 < 0.7\text{V}$	1.3	2.7	5.0	%
Stereo off level	ST <sub>OFF</sub>	The pilot mod such that $V_7 > 4.5\text{V}$		1.5		%
Total harmonic distortion (main)	THD main	L+R mod. Pin 16 output		0.3	1.3	%
Adjacent channel interference rejection ratio	Brej-3rd	$f_s = 113\text{kHz}$ , $V_s = 90\%$ , Pilot = 10% Pin 16 output, versus L-R mod. 1kHz demodulator output		40		dB
	Brej-5th	$f_s = 189\text{kHz}$ , $V_s = 90\%$ , Pilot = 10% Pin 16 output, versus L-R mod. 1kHz demodulator output		40		dB
[AM Characteristics]						
Current drain	$I_{CCO-AM}$	No input	15	25	35	mA
Output detector	$V_{OAM1}$	23dB $\mu$ , 30% mod, pin 16 output	100	180	360	mVrms
	$V_{OAM2}$	80dB $\mu$ , 30% mod, pin 16 output	200	320	500	mVrms
Signal-to-noise ratio	S/N <sub>AM1</sub>	23dB $\mu$ , 30% mod, pin 16 output	18	22		dB
	S/N <sub>AM2</sub>	80dB $\mu$ , 30% mod, pin 16 output	49	55		dB
Total harmonic distortion	THD <sub>AM1</sub>	80dB $\mu$ , 30% mod, pin 16 output		0.4	1.2	%
	THD <sub>AM2</sub>	80dB $\mu$ , 80% mod, pin 16 output		1.0	4.0	%
LED-ON sensitivity	$SD_{ON-AM}$		17	27	37	dB $\mu$
Oscillator buffer output	$V_{OSC-AM}$	No input, pin 30 output	110	160	220	mVrms
IF counter buffer output	$V_{IFBuff-AM}$	80dB $\mu$ , non-mod, pin 13 output	160	220	300	mVrms
ST IF output	$V_{STIF-AM}$	80dB $\mu$ , non-mod, pin 7 output	16	34	48	mVrms
S-meter output	$V_{SM-AM}$	0dB $\mu$ , non-mod	0	0	0.2	V

# LA1837M

## Package Dimensions

unit : mm

3073C

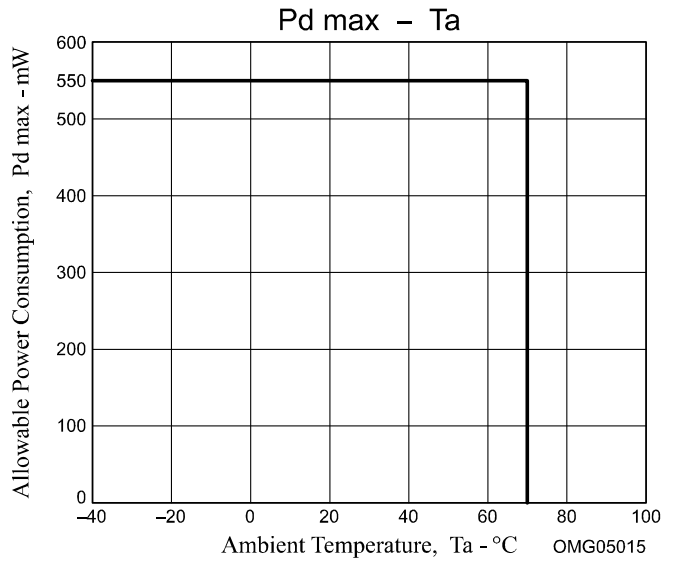
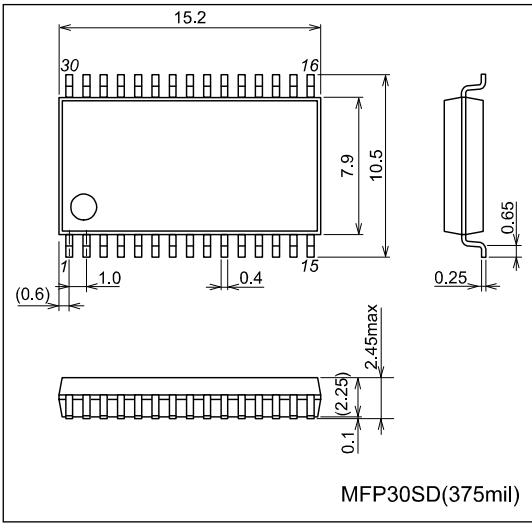

## Block Diagram

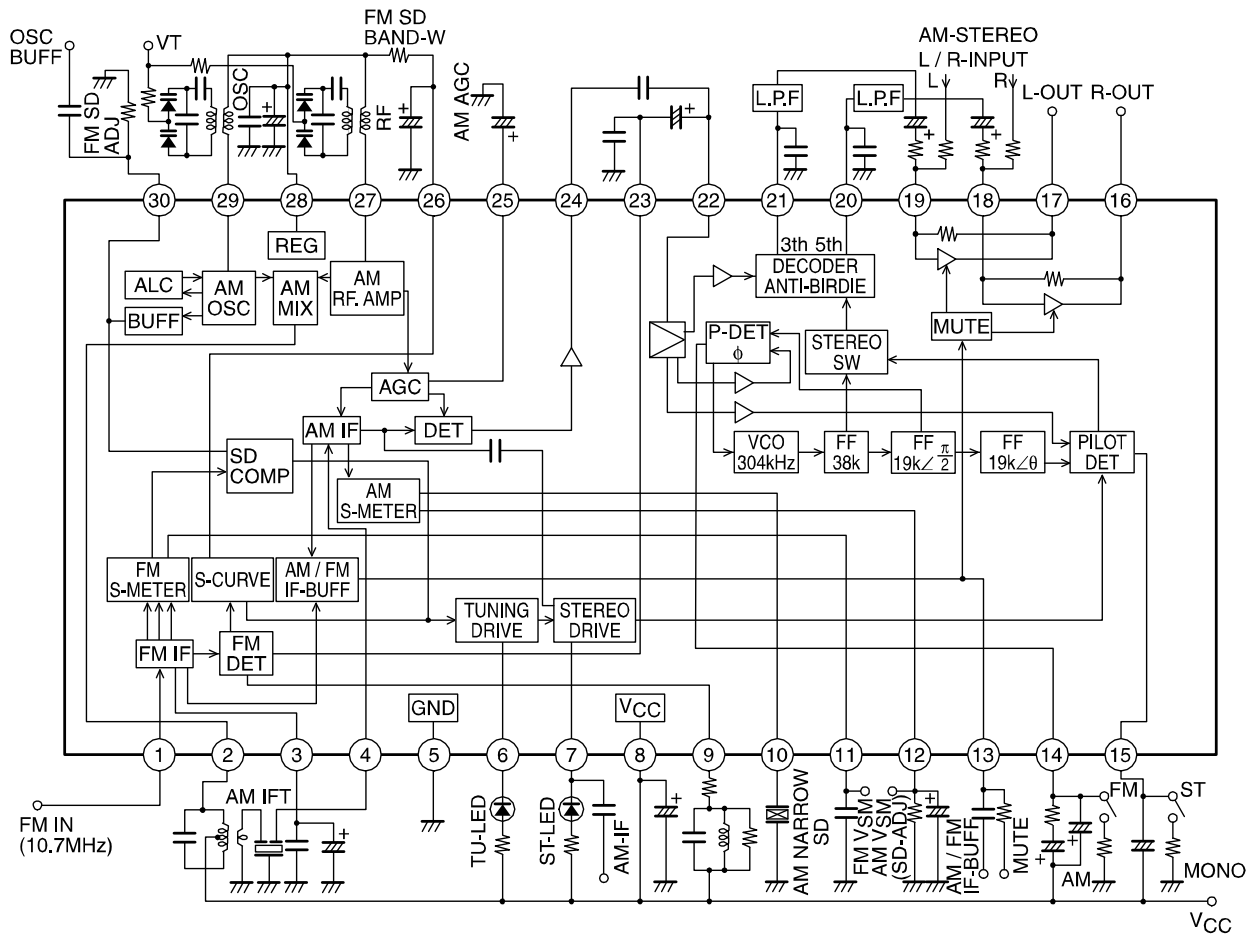

Coil Specifications

- AM oscillator (for the DUT)  
HW-50425 (Mitsumi Electric Co., Ltd.)

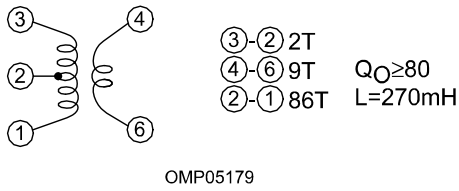

- IFT  
YD-1073-1 (Mitsumi Electric Co., Ltd.)

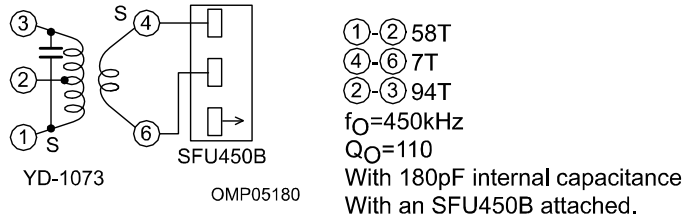

- FM-DET  
600BEAS-9715Z (Toko Electric Corporation)

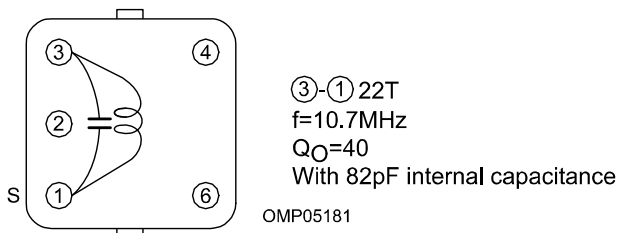

Pin Function

Pin No.	Pin	Pin voltage	Equivalent circuit	Pin function
1	FM IF input	Vreg	OMP05156	Input impedance $r_i = 330 \Omega$
2	AM mixer output	VCC	OMP05157	Connect the mixer coil between this pin and VCC.
3	FM IF input bypass	Vreg	See pin 1	Also used for the multiplex regulator filter
4	AM IF input	Vreg	OMP05158	Input impedance $r_i = 2 \text{ k}\Omega$
5	GND	0V		
6	TU-LED, ST-LED, AM - IF output	VCC VCC	OMP05159	Active low Open collector AM stereo IF output (pin 7) This pin must be set up with an influx current under 150μA.
8		VCC		
9	FM detector	VCC	OMP05160	Recommended detector coil 600BEAS-9715Z (The Toko Electric Corporation)

Continued on next page.

# LA1837M

Continued from preceding page.

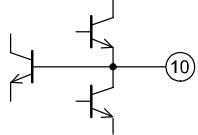
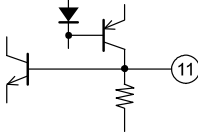
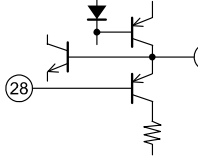
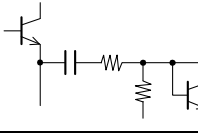
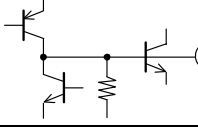
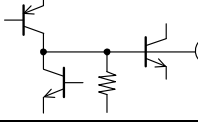
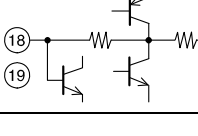
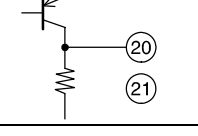
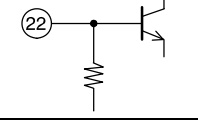
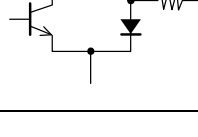
Pin No.	Pin	Pin voltage	Equivalent circuit	Pin function
10	AM narrow band ceramic filter connection	1.3V	 OMP05161	Recommended narrow band ceramic filter BFU450C4N (Murata Mfg. Co., Ltd.) When the narrow band SD function is not used, bypass this circuit by connecting a 50Ω resistor and a 0.047μF capacitor in series.
11	FM S-meter output	0V	 OMP05162	$R_L = 8k\Omega$
12	AM S-meter output, AM SD sensitivity adjustment	0V (AM)	 OMP05163	The AM SD sensitivity can be adjusted with an external resistor between this pin and ground.
13	AM/FM IF buffer output, Output control switch (muting switch)	0V	 OMP05164	$V_{13} \leq 0.5V$ : Reception state $1.4V \leq V_{13} \leq 2.2V$ : IF buffer output on $V_{13} \geq 3.5V$ : IF buffer output and muting on
14	Phase comparator low-pass filter (FM/AM switching)	$V_{CC}-1.4$ (FM) 0V (AM)	 OMP05166	The IC switches to AM mode when this pin is connected to ground through a resistor. Resistor value limits: 2.7kΩ (when $V_{CC} = 7V$ ) 3.9kΩ (8V) 5.1kΩ (9V) 6.2kΩ (10V) 7.5kΩ (11V)
15	Pilot detector low-pass filter (Forced monaural) (VCO stop)	$V_{CC}-1.0$	 OMP05167	When a current of over 50μA is sourced by this pin, the IC switches to forced monaural mode. The VCO is stopped if this pin is connected to ground. The resistor value limits are the same as for pin 14.
16 17 18 19	Post amplifier I/O	Verg Verg	 OMP05168	Output impedance $r_O = 200\Omega$ Pin 16: right output, pin 17: left output Inverting input pins Pin 18: right input, pin 19: left input $R_{NF} = 33k\Omega$
20 21	Multiplex output	3.5V 3.5V	 OMP05169	Output impedance $r_O = 3.3k\Omega$ Pin 20: Right channel deemphasis Pin 21: Left channel deemphasis
22	Multiplex input	2.9V	 OMP05170	Input impedance $r_i = 20k\Omega$
23	FM demodulated output	2.8V (FM) 2.8V (AM)	 OMP05171	Output impedance $r_O = 3.0k\Omega$ The separation can be adjusted with an external capacitor connected between this pin and ground. The $V_{Osub}/V_{Omain}$ ratio is set to be approximately 0dB.

Continued on next page.

# LA1837M

Continued from preceding page.

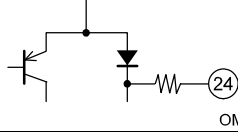
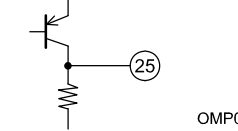
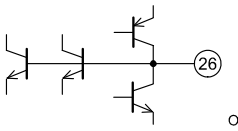
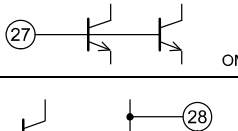
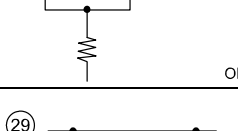
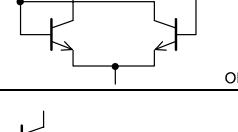
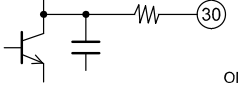
Pin No.	Pin	Pin voltage	Equivalent circuit	Pin function
24	AM detector output	0V (FM) 0.5V (AM)		Output impedance $r_o = 3.3k\Omega$ The AM frequency characteristics can be adjusted with an RC circuit connected between pin 22 and ground.
25	AM AGC	0V (FM) 0.5V (AM)		Internal load resistance $R = 11k\Omega$
26	AFC	Vreg		The FM SD bandwidth can be adjusted with an external resistor connected between this pin and pin 28.
27	AM RF input	Vreg		This pin must be held at the same potential as pin 28
28	REG	Vreg		Vreg = 3.6V
29	OSC	Vreg		Connect the oscillator coil between this pin and pin 28.
30	Oscillator buffer output, FM SD sensitivity adjustment	1.6V (FM) 1.3V (AM)		The FM SD sensitivity can be adjusted with an external resistor connected between this pin and ground. Output impedance $r_o = 20\Omega$

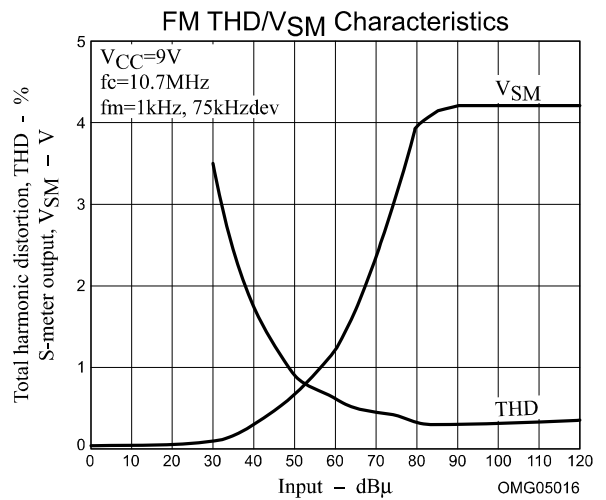
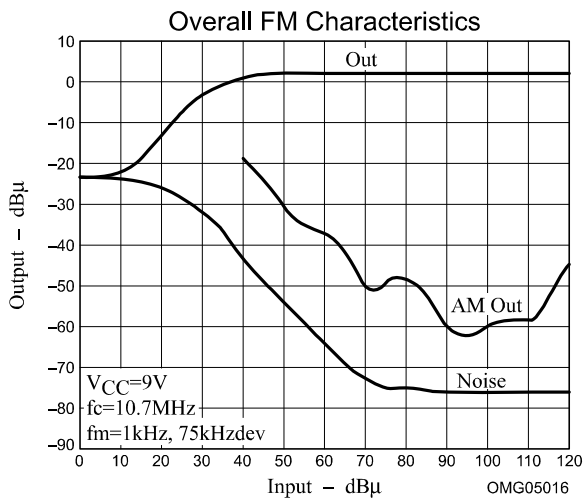

FM THD Bandwidth Characteristics

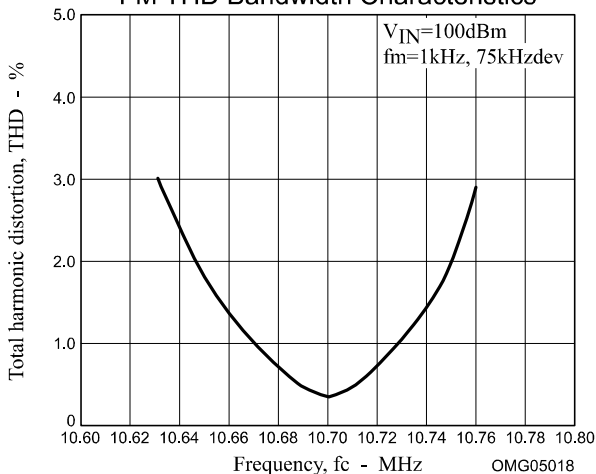

Distortion - Frequency Characteristics

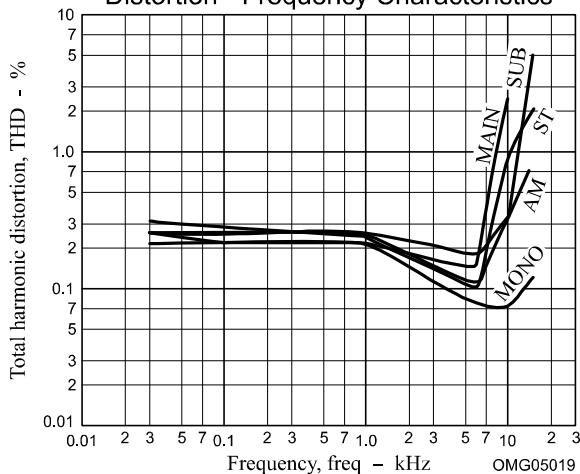

Separation - Frequency Characteristics

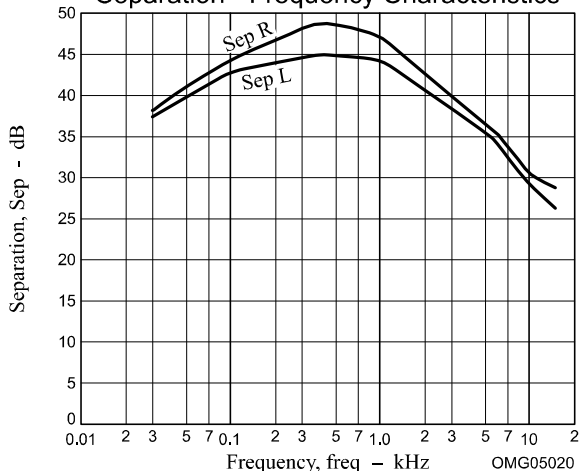

Adjacent Channel Interference Rejection Ratio

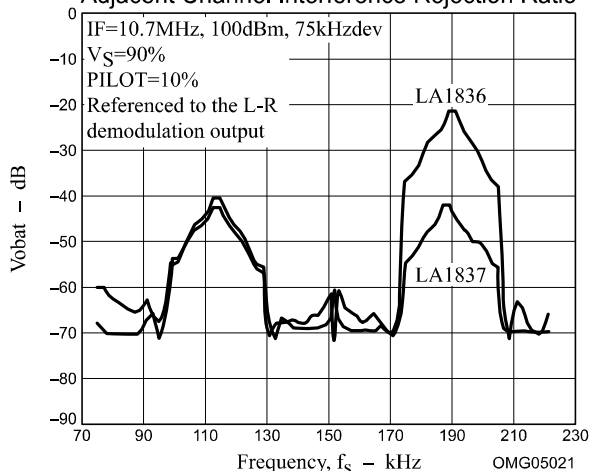

Capture Range Characteristics

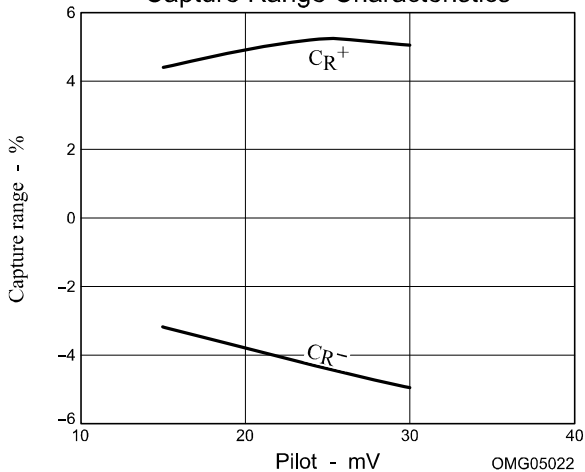

SD Sensitivity Adjustment Characteristics

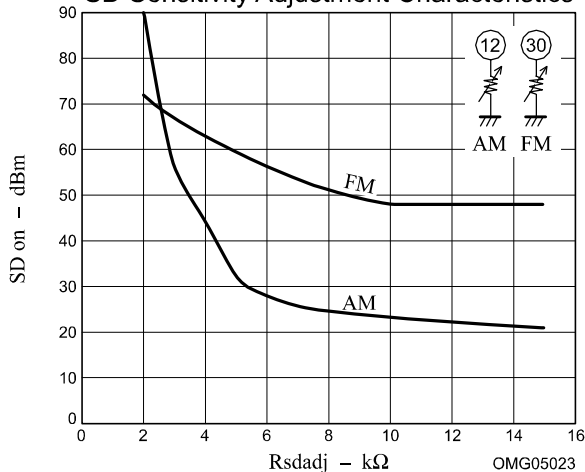

SD Sensitivity Adjustment Characteristics

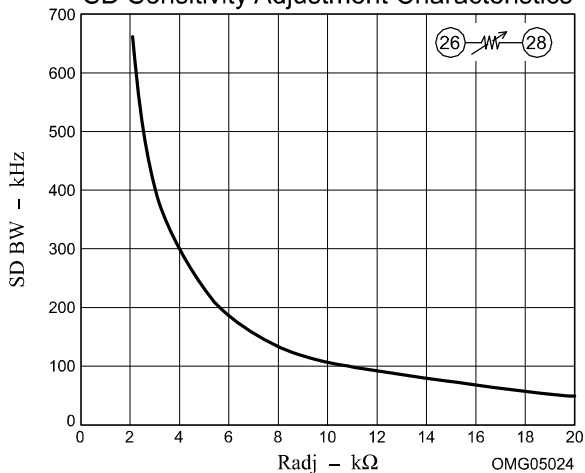

AM Overall Characteristics

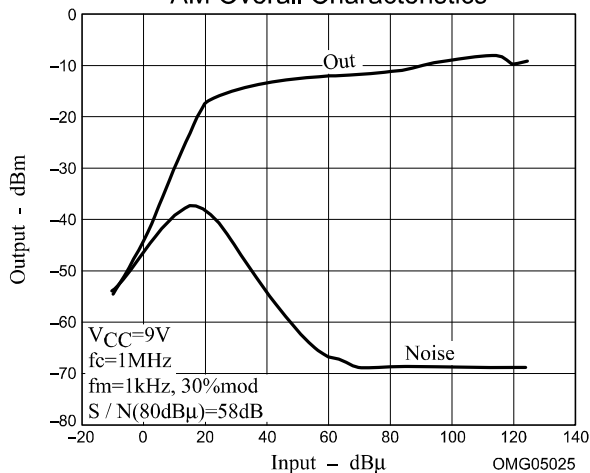

AM THD/V<sub>SM</sub> Characteristics

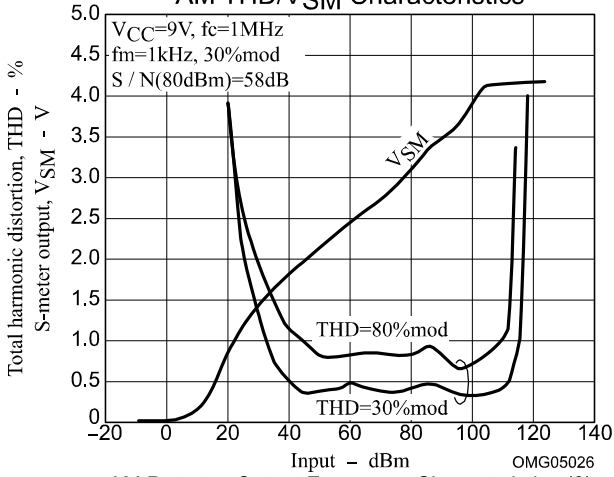

AM Detector Output Frequency Characteristics (1)

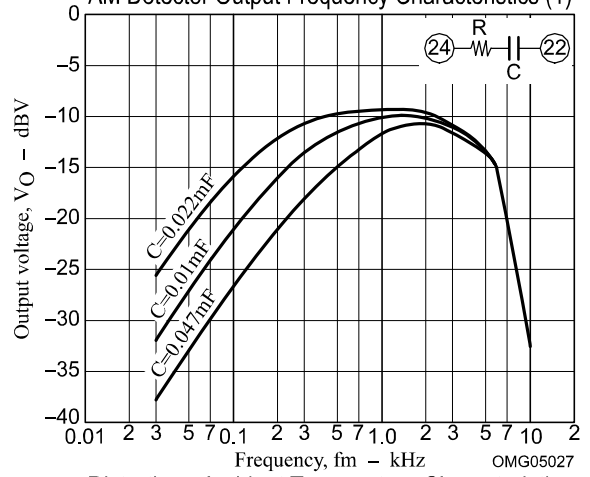

AM Detector Output Frequency Characteristics (2)

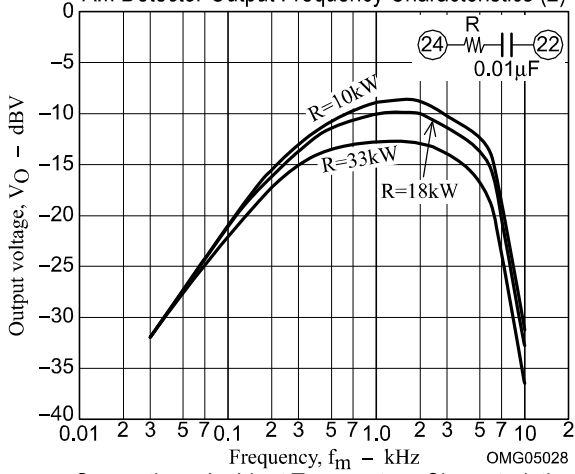

Distortion - Ambient Temperature Characteristics

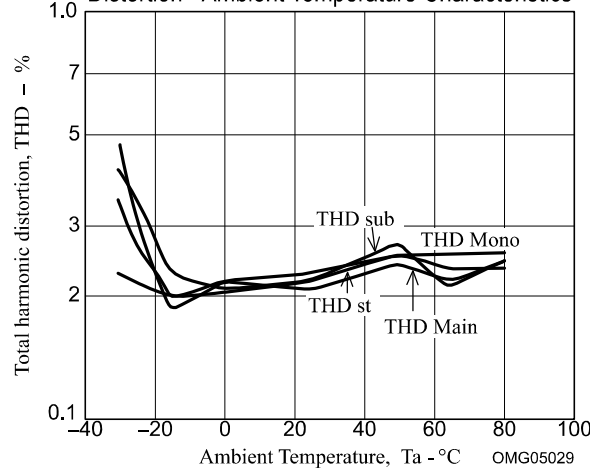

Separation - Ambient Temperature Characteristics

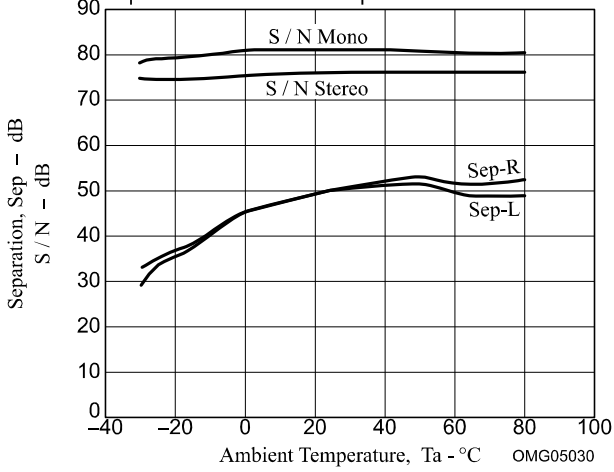



# LA1837M

## Test Circuit

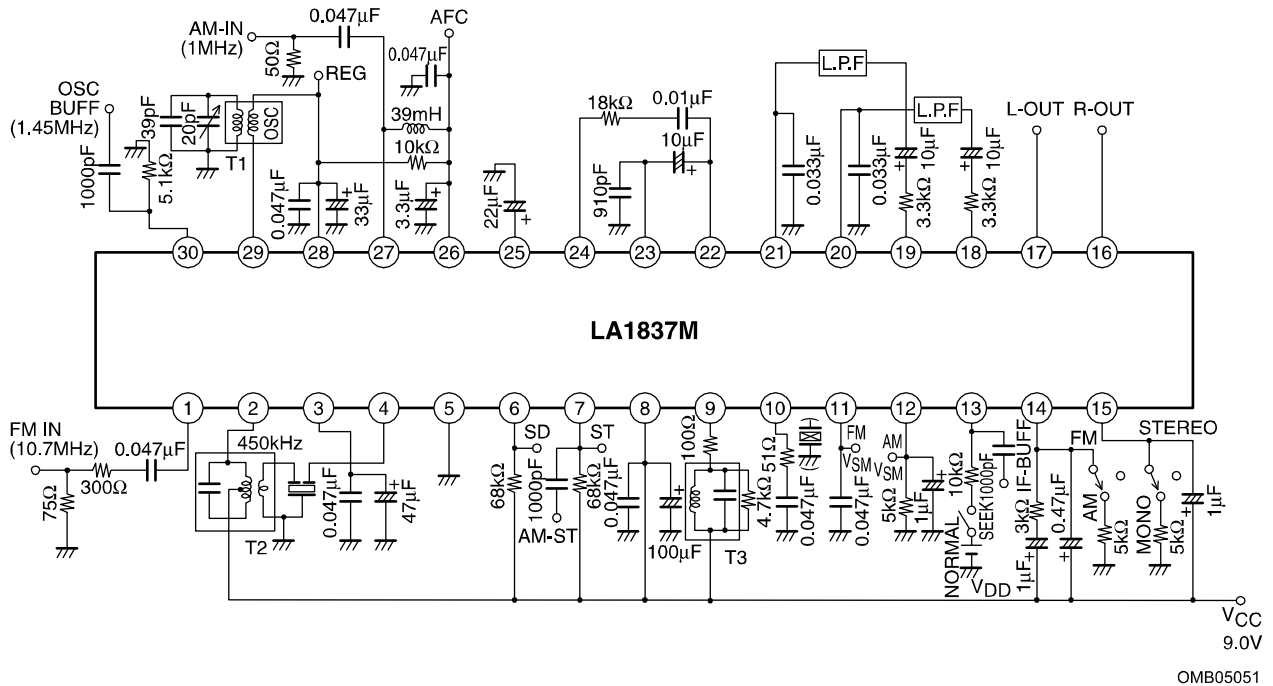

OMB05051

ON Semiconductor and the ON logo are registered trademarks of Semiconductor Components Industries, LLC (SCILLC). SCILLC owns the rights to a number of patents, trademarks, copyrights, trade secrets, and other intellectual property. A listing of SCILLC's product/patent coverage may be accessed at [www.onsemi.com/site/pdf/Patent-Marking.pdf](http://www.onsemi.com/site/pdf/Patent-Marking.pdf). SCILLC reserves the right to make changes without further notice to any products herein. SCILLC makes no warranty, representation or guarantee regarding the suitability of its products for any particular purpose, nor does SCILLC assume any liability arising out of the application or use of any product or circuit, and specifically disclaims any and all liability, including without limitation special, consequential or incidental damages. "Typical" parameters which may be provided in SCILLC data sheets and/or specifications can and do vary in different applications and actual performance may vary over time. All operating parameters, including "Typicals" must be validated for each customer application by customer's technical experts. SCILLC does not convey any license under its patent rights nor the rights of others. SCILLC products are not designed, intended, or authorized for use as components in systems intended for surgical implant into the body, or other applications intended to support or sustain life, or for any other application in which the failure of the SCILLC product could create a situation where personal injury or death may occur. Should Buyer purchase or use SCILLC products for any such unintended or unauthorized application, Buyer shall indemnify and hold SCILLC and its officers, employees, subsidiaries, affiliates, and distributors harmless against all claims, costs, damages, and expenses, and reasonable attorney fees arising out of, directly or indirectly, any claim of personal injury or death associated with such unintended or unauthorized use, even if such claim alleges that SCILLC was negligent regarding the design or manufacture of the part. SCILLC is an Equal Opportunity/Affirmative Action Employer. This literature is subject to all applicable copyright laws and is not for resale in any manner.